



WE MAGNETISE THE WORLD

*green
signed*[®]
by KENDRION



The New Rotary Solenoid CDR by Kendrion

Optimize your System – Rotation Instead of Linear Movement



INDUSTRIAL MAGNETIC SYSTEMS

BINDER

The New Rotary Solenoid by Kendrion

The CDR combines high compactness and short switching times with intelligent solenoid design.

Due to its compact design the CDR is the ideal solution for a variety of applications. A highly reliable transmission of the rotary movement to the shaft is guaranteed not least by the sensors responsible for the functional control.

The rotary solenoid excels by a potential switching time of 10 to 30 milliseconds and a rotation angle up to 90°. Size, functions and technical parameters can be customized to your individual requirements.

Energetically optimized for future-oriented applications

Moreover, due to the bistable design of the solenoid you save up to 80% of energy.

As opposed to conventional rotary solenoids the CDR only requires current for switching and is held currentless in rest position.



Due to its particularly environmentally-friendly design the solenoid has joined our Kendrion „green signed“ series.

Turning Lock

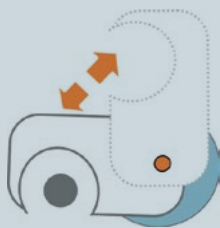

Eccentric (clamping)

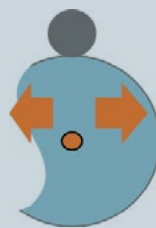

Flap / Cover (gar/air/light)

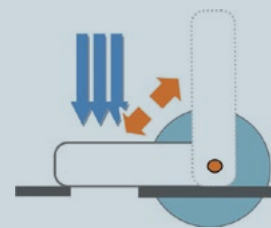

The advantages of the CDR at a glance

- Simple design, thus very cost-efficient
- Rotation angle of up to 90° possible
- High energy efficiency (current only during switching time)
- Low wear because of ball bearing
- Hall sensors can be integrated for low extra charge
- Modular design, easy to customize

The ideal choice for your application

There is a variety of applications in which the use of a rotary solenoid (instead of a linear actuator) facilitates the application.

- Fewer components
- End position detection
- Increased process reliability

Technical data of the preferred option CDR 030:

Rotation angle	90°
Supply voltage	24 V DC
Model	Bistable (change of position by pole reversal) Free strands
Duty cycle	15%
Power	30 W
Torque (power ON)	1.2 (start) - 3.5 (max.) Ncm
Detent torque (power OFF)	3.2 Ncm
Protection class	IP30
Environmental temperature	-10 bis +40°C
Hall sensor (optional)	Minus switching, 5-30 V DC, max 30 mA

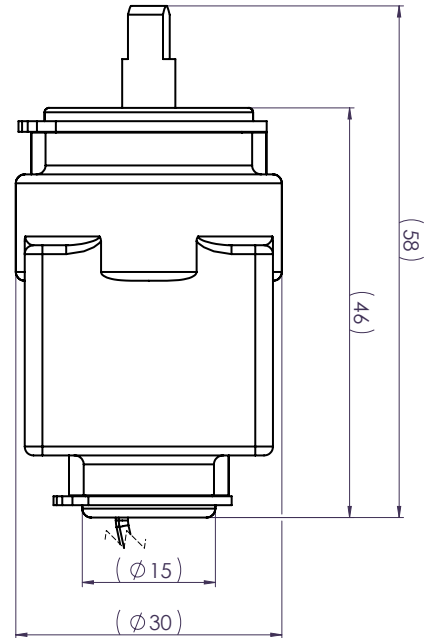

Switch system

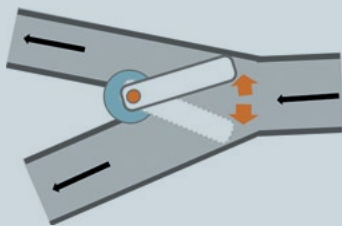

Pad printing

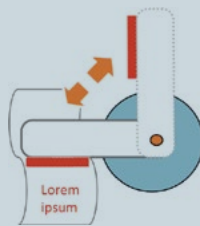

Cover system

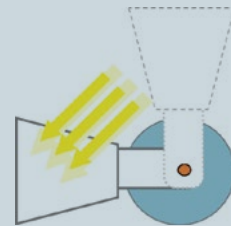

Customization Options

- Hall sensor one- or double-sided
- Damped stop can be integrated
- Mono- und bistable designs possible
- Different voltages possible
- Duty cycle of up 100% possible
- Higher protection class feasible
- Rotation angle between 20 and 150° feasible

Due to its modular design we can adapt the CDR fast and ideally to your requirements.

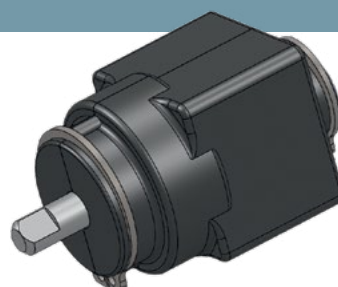



WE MAGNETISE THE WORLD

Kendrion (Donaueschingen/Engelswies) GmbH
Hauptstr. 6
72514 Inzigkofen-Engelswies
Germany
Tel: +49 7575 208-0
Fax +49 7575 8009-3190
sales-ims@kendrion.com
www.kendrion.com